

Comparison of full specification vu meters and Vintage Audio Level Meter range

The response curves below give a comparison of the full specification vu meters with that of a Vintage Audio Level Meter AL15, AL19R, AL20 and AL20SQ.

A low range ac voltmeter offering a performance close to that of a full specification vu meter. Suitable for connecting across a 600Ω line and self contained except for requiring an external 3k6 resistor. Calibrated for use with a 3k6 ohm resistor 4vu above the scale marking so that the reference deflection (0vu) is produced by a signal 4vu above 1mW in 600Ω (1.228V). The performance of the meter is based upon the requirements IEC 268-17.

The response curves below give a comparison of the full specification vu meter with that of a typical AL19R meter. A variation in overswing between 0 and 5% can occur since the damping is not individually adjusted on each meter but allowed to fall within normal process parameters.



Vintage AL20SQ

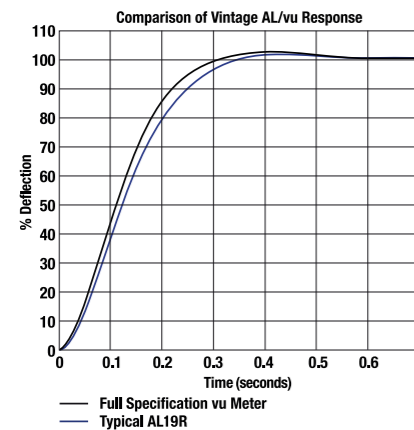

Pointers and dials

The combination of 'pear' shaped pointer and conventional arc scale on translucent buff coloured dial results in an easily read meter, even when monitoring a row on a large console. A white dial can be specified if required. The standard scale is based on the vu 'A' scale but the 'B' scale is also available.

Zero adjuster

Positioned on the rear as standard.

Operating Temperature

-25°C to +55°C.

Terminals

AL15 - 6mm tabs or flying leads are available

AL19R - 6mm tabs are supplied as standard but threaded studs or flying leads are available.

AL20 - Flying leads 125mm/5" long are standard but 6mm tabs are available.

AL20SQ - Flying leads 125mm/5" long are standard but 6mm tabs are available.

Europe

Sifam Tinsley Instrumentation Ltd

Central Building, Woodland Close,
Old Wood Trading EA, Torquay,
Devon, England, TQ2 7BB

Tel : +44 (0) 1803 615139

Fax : +44 (0) 1803 616800

Email : sales@sifamtinsley.com

Web : www.sifamtinsley.com

: www.sifam.com



Key Features

- Four distinctive styles
- High quality modular construction
- Taut band core magnet movements

Vintage Audio Level Meters

Types AL15, AL19R, AL20, AL20SQ

The Vintage style meter has been introduced by Sifam in response to the demand for more classically styled meters seen on many traditional consoles and rack mounted units. The distinctive 'retro' styling with contemporary construction gives high performance at an affordable price. The Vintage AL range is available in four styles.

This range of Audio Level (AL) analogue meters complements the Fast Response (FR) and Industrial meters available in the same distinctive vintage styling.

Features and Benefits

- Distinctive 'retro' styling with contemporary construction
- Audio Level (vu scale) ranges
- Taut band core magnet movement incorporated as standard
- Rugged movements for portable or fixed audio applications
- No calibration effect when mounted on a ferrous panel
- High performance at affordable price
- Illumination options

Type AL15

Square 36.5mm bezel, with four fixing holes

- Suitable for less than 1U vertical rack mounted applications
- Front of panel mounting with full bezel
- Internal LED illumination option
- Constructed with glass window and high impact rear body moulding. Bezel moulded in black ABS
- vu scale

Type AL19R

Rectangular 46.3 x 42.3mm bezel

- Front panel mount with full bezel, rear panel stud fixings
- Suitable for 1U rack mounted applications
- Constructed with transparent acrylic front and high impact rear body moulding. Bezel moulded in black ABS
- Internal LED illumination option
- vu scale

Type AL20

Circular, 55.6mm dia. bezel, suitable for rear panel clamp mounting

- Constructed with gloss black phenolic moulded front with glass window and high impact translucent rear body moulding
- Rear 'Festoon' or LED illumination and internal LED illumination options are available
- vu scale

Type AL20SQ

Square 57.1mm bezel, front panel mount with four fixing holes

- Constructed with gloss black phenolic moulded front with glass window and high impact translucent rear body moulding
- Rear 'Festoon' or LED illumination and internal LED illumination options are available
- vu scale

Type AL15

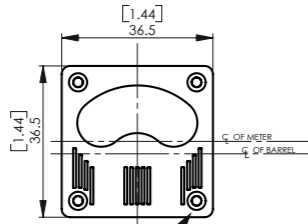

4 FIXING HOLES SUITABLE FOR M2 CSK. HD. SCREWS OR No.2-56UNC CSK. HD. SCREWS

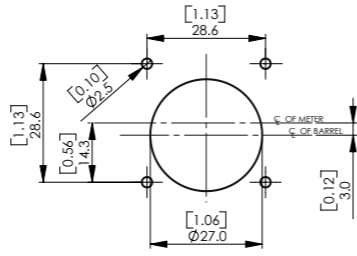

PANEL CUT OUT DETAILS

OPTIONAL 'TAB TERMINALS' FOR METER CONNECTIONS ONLY 6.3 X 0.8 (1/4" x .032")

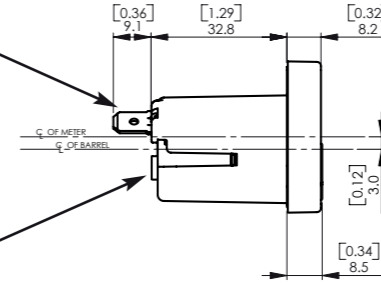

REAR ZERO ADJUSTMENT ONLY

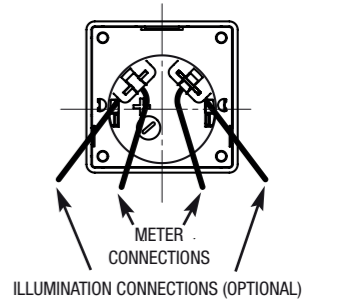

NOTE:- INCH EQUIVALENTS SHOWN IN BRACKETS

Type AL19R

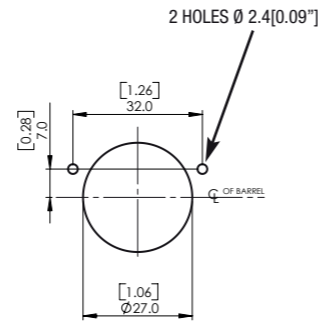
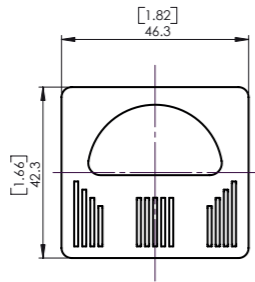

PANEL CUT OUT DETAILS

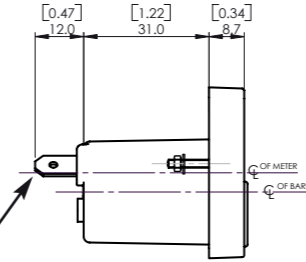

2 TERMINALS TO BS5057 6.3 [0.25"] x 0.8 [0.032"], HOLE Ø 2[0.08"]

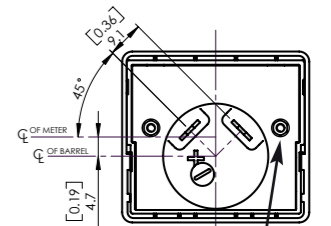

2 FIXING STUDS M2 x 11mm [0.43"] LONG

NOTE:- MAX PANEL THICKNESS 6mm [0.24"]

Type AL20

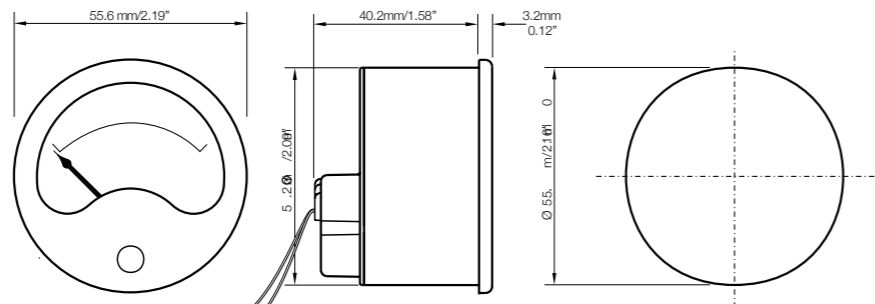

WIRE SIZE 1.2mm OD (7/0.2mm)

STRAIGHT TABS OPTION

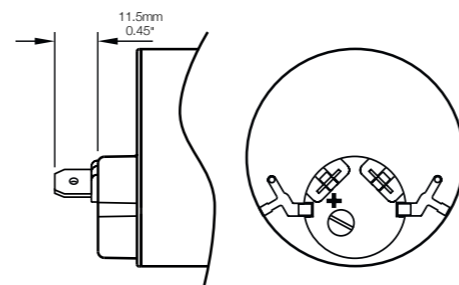

BENT TABS OPTION

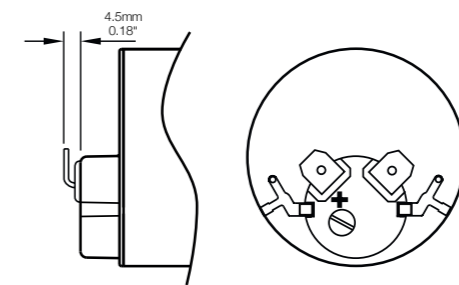

This is available as a rear mounted factory fitted option. The unit contains a Ø 6mm 'festoon' style lamp available in 6V, 12V or 24V. Please contact the sales office for more information.

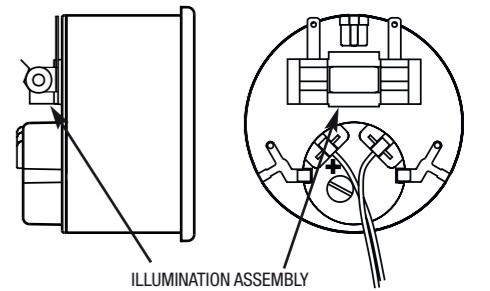

ILLUMINATION ASSEMBLY

Type AL20SQ

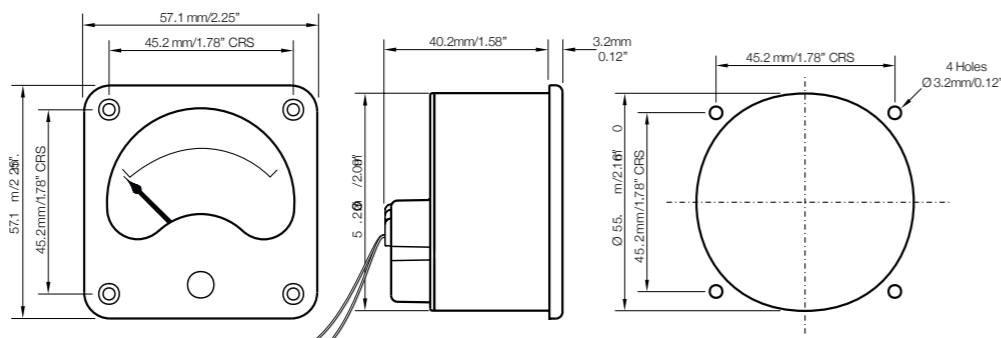

WIRE SIZE 1.2mm OD (7/0.2mm)

STRAIGHT TABS OPTION

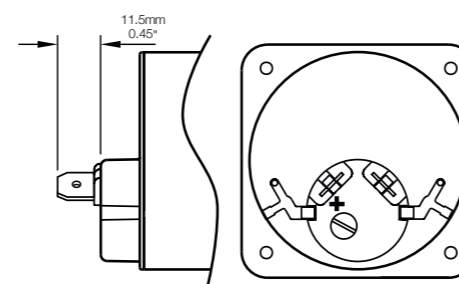

BENT TABS OPTION

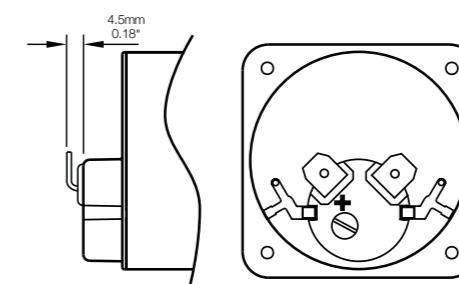

This is available as a rear mounted factory fitted option. The unit contains a Ø 6mm 'festoon' style lamp available in 6V, 12V or 24V. Please contact the sales office for more information.

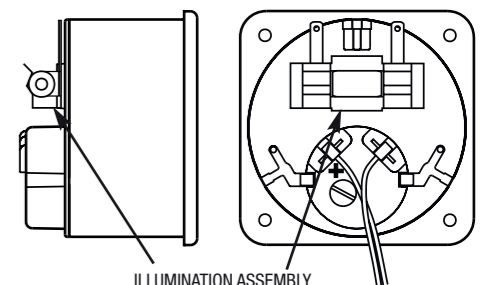

ILLUMINATION ASSEMBLY